

USER MANUAL

Published October 7, 2015

Software Version 8.99E

ZAXCOM

ZAXCOM.COM



ZFR200/300

Small Body Pack Recorder

- ZFR OVERVIEW 4**
 - SYSTEM FEATURES 4
- KNOWING YOUR ZFR200 / 300 5**
- HOME SCREEN EXPLAINED 7**
- MAIN MENU 8**
 - NAVIGATING THE MAIN MENU 8
 - EXITING THE MAIN MENU 8
 - MICROPHONE GAIN ADJUST 8
 - HIGH PASS FILTER 8
 - TIME CODE FRAME RATE SET 8
 - TC JAM MODE SELECT 9
 - TIME CODE SOURCE SELECT 9
 - SD CARD FORMAT 10
 - TIME LEFT ON CARD 10
 - LOCK PAGE 11
- EXTENDED MENU 12**
 - ENTERING AND NAVIGATING THE EXTENDED MENU **ERROR! BOOKMARK NOT DEFINED.**
 - EXITING THE EXTENDED MENU **ERROR! BOOKMARK NOT DEFINED.**
 - HIGH PASS FILTER 12
 - RECORD FORMAT SET 12
 - IFB VOTING ENABLE 12
 - IFB MODE **ERROR! BOOKMARK NOT DEFINED.**
 - ZAXNET RECEIVE FREQUENCY SET 13
 - ZAXNET TRANSMIT FREQUENCY SET 14
 - IFB RECEIVE PULSE SET 14
 - IFB TRANSMIT POWER LEVEL 14
 - IFB RECORD BEEP 15
 - POWER-UP MODE 15
 - SD CARD FORMAT 15
 - TC JAM MODE SELECT 16
 - TIME CODE SOURCE SELECT 16
 - MUTE TIME CODE TRANSMISSION UNTIL JAMMED 16
 - GROUP ID SET 17
 - UNIT ID SET 17
 - DYNAMICS 18
 - BATTERY TYPE SET 19
 - RECORDING MODE SET 19
 - ALLOW IFB REMOTE CONTROL 19
 - LOW BATTERY STOP SET 19
 - AUTOMATIC RECORD AFTER BOOTUP 20
 - ZFR NAME SET 20
 - HIDE ENCRYPTION MENU 20
 - ENCRYPTION CODE SET 21
- MEDIA 22**
 - MEDIA CAPACITY 22
 - RECORDING FORMAT 22

FIRMWARE23
 UPDATING ZFR FIRMWARE 23

INPUTTING AUDIO24

RECOMMENDED MICROPHONES24

WIRING DIAGRAMS.....24
 TWO WIRE MICROPHONE CONFIGURATION 24
 THREE WIRE MICROPHONE CONFIGURATION 24
 STEREO MICROPHONE CONFIGURATION 24
 BALANCED LINE LEVEL AND TIME CODE INPUT 25
 STEREO LINE LEVEL – FOR STEREO ZRF RECORDERS 25

PRODUCT SUPPORT26

SPECIFICATIONS.....27

ZAXCOM WARRANTY POLICY AND LIMITATIONS.....28

ZFR Overview

The Zaxcom ZFR (Zaxcom Flash Recorder) is a small recorder that is the same size as Zaxcom wireless transmitter, and can accept standard lavalier microphones. A stereo ZFR can accept two lavalier microphones.

The ZFR can be used as an easy way to record ISO tracks on multiple talent with no fears of being out of range or having to deal with RF issues.

The ZFR can be set that after power up it will jam time code via ZaxNet and will then start transmitting QC audio with time code within 10 seconds. ZaxNet transmission from the ZFR allows audio to be monitored in close range. The ZaxNet signal can be used to quickly determine how the audio sounds, and can be used as a time code master to wirelessly jam other recording body pack recorders or recording wireless transmitters. The body packs can optionally re-jam time code every few minutes to maintain sub-frame accurate time code lock. At the end of your shoot you gather each SD memory card from the ZFR and deliver them to post.

Post production can then easily drop each ISO track into their non-linear edit system and have a clean time coded audio track to work with.

Recording systems can be as simple as a single ZFR recorder and a single ERX2TCD receiver to wirelessly monitor the audio and time code from the recorder. Any number of ZFR recorders can be utilized to form an unlimited virtual multi-track recording system. The advantage of this system is that it eliminates the limitations of wireless microphones. No longer will FM wireless audio quality, range, or RF interference, limit the ability of a sound mixer to achieve audio quality usually found only in a studio setting.

System Features

- The ZFR 200 or 300 can be ordered as either stereo or mono
- Fault tolerant broadcast quality recording
- Audio recording at 24 bits/48 kHz
- Up to 96 hours of audio directly on a 16 GB removable card
- Backlit graphic liquid crystal display
- Adjustable high pass filter
- Lightweight rugged design
- Integrated TC reader/generator accurate to 1 frame in 6 hours
- Efficient keypad for one-handed operation
- Integrated and encrypted IFB channel in recorder
- Integrated ZaxNet Audio and Time Code Reception and Transmission

ZFR200

Weight	3.0 oz (88 grams) without battery
Dimensions (H x W x D)	2.4" x 2.4" x 0.65" (60 mm x 60 mm x 17 mm)
Internal Power (Battery)	up to 5 hours (one AA Lithium or NiMH)

ZFR 300

Weight	3.0 oz (85 grams) without battery
Dimensions (H x W x D)	3.0" x 2.4" x 0.65" (76 mm x 61 mm x 16.5 mm)
Internal Power (Battery)	up to 12 hours (two AA Lithium or NiMH)

Knowing your ZFR200 / 300

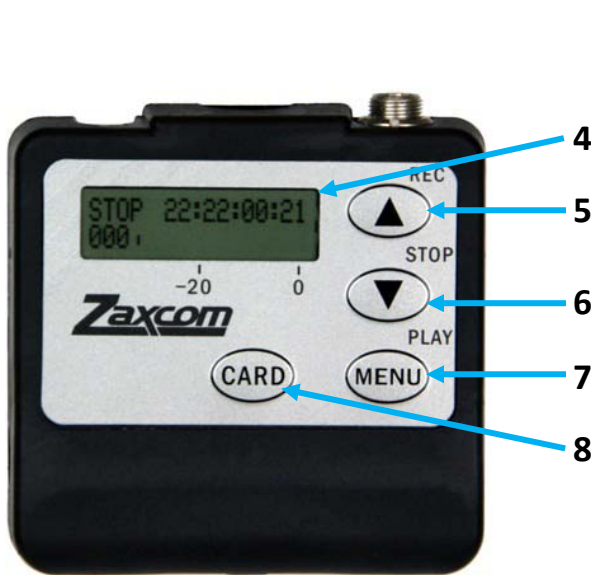
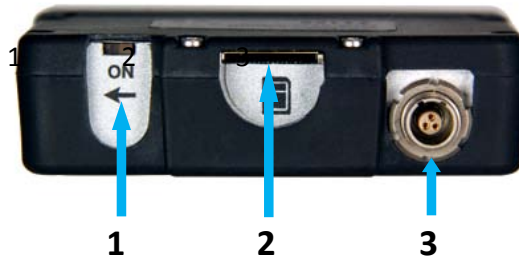

ZFR200



ZFR300



1. Power switch
2. Micro SD media slot
To insert a Micro SD card, start with the screen of the ZFR facing you, turn the card so the finger contacts are facing you and pointing down towards the slot. Insert the card into the slot and press it down until you hear a slight click. To remove the card, press the card in until you hear the same click again.
3. Microphone / Time Code input connector (3 pin Lemo)
4. LCD display
5. Card key
6. INC / Record key
 - Pressing the key while in a menu page will increase the parameters of that menu item.
 - While in the home screen press the key simultaneously with the card key to put the ZFR into record.
 - Press the key when the ZFR is stopped and the ZFR will play back the last file.
 - Press the key while playing back will fast forward the playback.
 - While in stop mode press and hold the key will cause the ZFR to advance to the next segment.
7. DEC / Stop Key
 - Pressing the key while in a menu page will decrease the parameters of that menu item.
 - While in the home screen press the key simultaneously with the card key to stop recording.
 - Press it while playing back will stop play back.
 - While in stop mode press and hold the key will cause the ZFR to jump back to the previous segment.
8. Menu / Play Key
 - Press the key to access the main menu.
 - Pressing the key again will take you to additional menu items.
 - Holding the key while powering up will take you into the extended menu.
 - Press the menu key simultaneously with the card key will playback a segment.
9. Battery compartment
ZFR200 will use 1 AA battery and the ZFR300 will use 2 AA batteries. The ZFR can use alkaline, Lithium or NiMH batteries.

Home Screen Explained

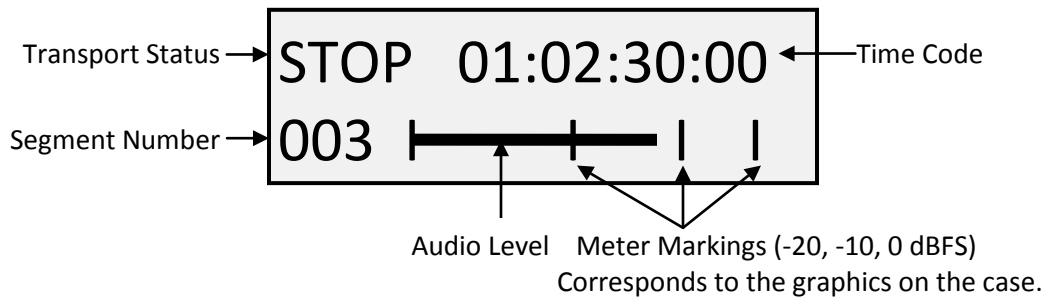

Transport Status - Displays the current mode of the on-board recorder.

- STOP – Recording / Playback is stopped
- LREC – ZFR is recording and LOOP RECORD mode is enabled
- REC – ZFR is recording and NON-LOOP RECORD mode is enabled
- PLAY – The ZFR is playing back an audio file.

Time Code – Display is based on the current mode.

- When stopped – Displays the location where playback will start.
- During playback – Displays the current location as the segment plays back.
- While recording – Displays the time code that is being recorded as it is coming from the internal time code generator.

Segment Number

- In record mode shows the current record segment.
- In playback mode shows the segment being played back.

Please note the maximum number of recording segments that can be recorded on any one card, regardless of the size of the card is 256.

Main Menu

Navigating the Main Menu

- Press the MENU key to enter the menu.
- To advance to the next menu press the MENU key again.

Exiting the Main Menu

- To exit the menu at any time press and hold the MENU key for 1.5 seconds

Microphone Gain Adjust



The microphone gain is adjusted from this menu. This page displays the gain setting in decibels and a meter that indicates the audio signal. The meter is displayed horizontally from left to right.

If the ZFR is a stereo unit, and it is set to stereo mode, two meters will be displayed - one for each channel. Please note the gain while in stereo mode is applied to both sources.

High Pass Filter

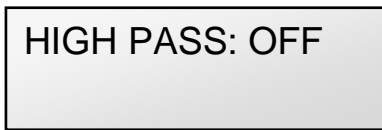

The high pass filter is turned on and adjusted from this menu.

- The high pass filter range is 70Hz to 220Hz and can be adjusted in 10Hz increments.

Time Code Frame Rate Set

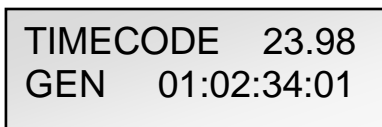

This menu is where the time code frame rate is set.

The ZFR will lock to, and record all standard time code frame rates.

- 23.98, 24, 25, 29.97DF, 29.97DF, 30 DF, 30 NDF

TC Jam Mode Select

TC JAM MODE:
AUTO-JAM NORMAL

When using record run time code this menu controls if the ZFR will go into record when it receives a record run time code.

- **AUTO-JAM NORMAL**– The ZFR will continuously jam time code via ZaxNet.
- **AUTO-LOAD REC RUN** – The ZFR will continuously jam time code via ZaxNet and will start and stop the recording if the unit is receiving record run time code.

In this mode the ZFR will go into record mode when it detects rolling time code. And will stop when the time code stops. If time code is lost because the IFB signal is too weak the unit will not stop but will continue in whatever state it was in until the time code signal is restored.

Time Code Source Select

TC SOURCE:
IFB (RF)

This menu selects how the ZFR will receive its time code.

- **IFB (RF)** – The ZFR will receive time code via ZaxNet being broadcast from Nomad, a QRX, IFB100/200, TRX900CL, a TRX transmitter or a ZFR recorder.
- **AUDIO INPUT**– The ZFR, with a proper cable, will receive time code via the microphone input. When time code is connected, it takes the ZFR approximately three seconds to recognize the TC. The screen displays TIME CODE followed by JAM when it is recognized. When the word JAM disappears, the time code input source can be disconnected and normal operation can be resumed. Please Note that when using the microphone input connector, the audio level of the time code signal needs to be between -30 and -10 dBFS on the unit's meter. Any level above -10 may cause clipping, which will prevent proper reading of time code.

SD Card Format

This menu will only appear if a card was inserted prior to booting up

PRESS UP KEY 5X
TO ERASE CARD

The Micro SD card is erased and formatted from this menu. Please note that even though many cards are sold preformatted, you must format the card in the ZFR prior to any recording. Only cards formatted in the ZFR will work properly.

Before formatting the card, you may want to name the ZFR. When you name the ZFR that name is included in the recorded file names. By naming the ZFR it makes it easier to differentiate files from different recorders. So for example you can name the card with the talents name or any other unique identifier. The card name menu is located at the end of the extended menu.

To Format an SD Card:

1. With the power off, insert the memory card into the media slot with the card label to the back of the unit. Press the card all the way in until it "clicks".
2. Power up the transmitter and advance to this menu.
3. Press the INC key 5 times.
4. You will see "FORMATTING FAT 32" displayed on the screen.
5. After about a minute the ZFR will displays "SUCCESS" or "FORMAT FAILED ERROR".
6. If "SUCCESS" appears power cycle the ZFR.
7. If you see "FORMAT FAILED ERROR" try to re-format the card and if it fails again it is not advised to use that card in the recorder.

Time Left on Card

TIME LEFT 20H
TIME USED 4H

This page displays the remaining record time left on the card and the time already recorded on the card. Please note that this page will not be displayed if the card was not inserted prior to boot up.

Lock Page

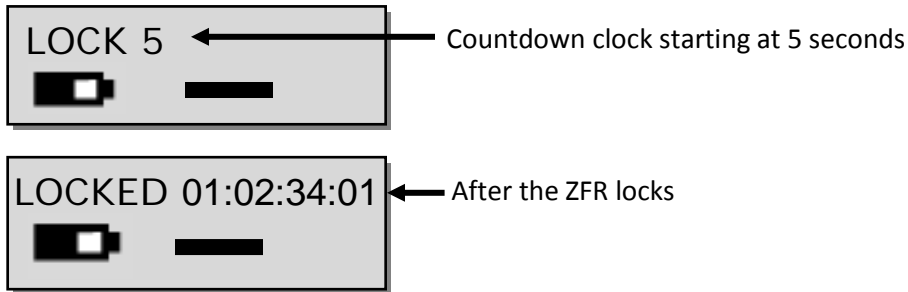

This page enables a lock function to prevent any accidental key presses.

When you land on this page the countdown clock will begin. After 5 seconds the ZFR will lock and the display will indicate that it is LOCKED followed by the time code.

If you exit this screen before the 5 seconds is up the transmitter will not lock.

To Unlock the ZFR

- Simultaneously press the MENU and INC keys.
Or
- Powering down the unit will clear the lock.

Extended Menu

High Pass Filter

HIGH PASS: OFF

The high pass filter is turned on and adjusted from this menu.

- The high pass filter range is 70Hz to 220Hz and can be adjusted in 10Hz increments.

Record Format Set

TX FORMAT:
MONO (US)

This menu is for adjusting the recording mode on the ZFR recorder.

- **US MONO** - This setting is used for mono recording.
- **STEREO** - This setting is used if you have a stereo ZFR and are recording a stereo source.

Please note that you must reboot the ZFR after changing this setting.

IFB Voting Enable

IFB VOTING
NORMAL (OFF)

This menu allows you to enable / disable the IFB Voting function.

The purpose of IFB voting is to allow the ZFR's ZaxNet receiver to choose and switch to the stronger signal from two different ZaxNet transmitters. One purpose of this is if you are on a large set you can place a second IFB transmitter at a different location and the ZaxNet receiver will choose the stronger signal. To use the IFB voting feature just set the second IFB transmitters frequency to exactly 2MHz higher than the first frequency.

Please note that the IFB voting is only available if the IFB in the unit will never go into transmit mode. So the IFB RX to TX mode needs to be set to normal RX, and RX mode is not set to off.

IFB Mode

IFB RX TO TX:
OFF (NORMAL RX)

Receive only mode.

← The ZaxNet transceiver will only receive ZaxNet and NOT go into transmit mode. Therefore no ZaxNet TC and/or audio will be transmitted. This shuts off the ZaxNet transmitter.

IFB RX TO TX:
0 SECS: TX ONLY

Transmit only mode.

← The ZaxNet transceiver will only transmit ZaxNet TC and audio and will NOT receive wireless TC or ZaxNet commands.

IFB RX TO TX:
20 SECS

Receive then Transmit mode.

← After boot up the ZaxNet transceiver will search for a ZaxNet signal for the selected time so it can receive and lock time code before it begins to transmit TC and confidence audio.

This menu adjusts the mode of the ZaxNet IFB transceiver and how long after power up it will search for ZaxNet time code before it begins transmitting IFB audio for monitoring purposes. This is necessary if you want your transmitter to lock to ZaxNet time code before you use your ZaxNet transmitter to send confidence audio.

Please note that after changing this setting you must power cycle the ZFR.

ZaxNet Receive Frequency Set

RXFREQ: 2.403

When the ZaxNet receiver is receiving a ZaxNet signal you will see:

RXFREQ: 2.403 RX
SIGNAL: 28

← ZaxNet receive frequency and RX shows that ZaxNet is being received

← ZaxNet signal strength meter

← Signal strength

This is where the ZaxNet receive frequency is set.

The ZaxNet receive frequency is the frequency that the ZaxNet receiver will get its wireless time code and remote control commands on. This frequency will need to match the frequency of the corresponding ZaxNet transmitter. The ZaxNet transmitter can be a QRX with QIFB, Nomad, TRX900CL or IFB100/200. The TRX can also receive ZaxNet time code from a TRX transmitter or another ZFR recorder that is transmitting ZaxNet on this frequency.

ZaxNet Transmit Frequency Set

IFB TX FREQ:
2.420

This is where the ZaxNet transmit frequency is set.

The ZaxNet transmit frequency is the frequency that the ZaxNet transmitter will broadcast time code and audio on for the purpose of confidence audio monitoring via an ERX receiver or Nomad. Please note this transmitted audio is for quality control purposes and the expected range will be less than 20 feet.

IFB Receive Pulse Set

This menu will only appear if IFB is set to go into transmit mode.

IFB RX PULSE:
NEVER

← The ZaxNet transceiver will stay in transmit mode and never go into receive mode.

IFB RX PULSE:
600 SECS

← In this example the ZaxNet transceiver will go out of transmit mode every 10 minutes. You would use this setting if you are monitoring audio via an ERX receiver and you still want the ZFR to update time code.

This is where you set how often the ZaxNet transceiver will stop sending and search for time code when it is sending ZaxNet confidence audio.

When enabled this tells the ZaxNet transceiver to stop transmitting once every XXX seconds to go into receive mode so it can re-jam its time code wirelessly via ZaxNet. You would use this when you are using ZaxNet on the ZFR for confidence monitoring and you still want to update time code at set intervals. When the ZFR searches for ZaxNet it will temporarily go out of transmit mode for approximately 1 second as it searches for ZaxNet time code.

- The settings are NEVER or any interval between 10 and 999 seconds.

IFB Transmit Power Level

IFB TX POWER: 7

This is where the power level of the ZaxNet transmitter is set.

- The power settings are any interval between 0 and 7 with 7 being the highest.

IFB Record Beep

IFB RECORD BEEP:
OFF

The IFB record beep is an audible beep that is heard on the ZaxNet confidence audio only. When the record beep is set to ON, and the ZFR is recording, the audio sent to the ERX via ZaxNet will have an audible beep, in 20 second intervals, giving you conformation that the ZFR is indeed recording. The beeps will only be heard in the ERX and will not be recorded on the card.

Power-Up Mode

POWER UP MODE:
LOCKED

This menu sets what happens to the keys on the face of the ZFR after power-up.

- **LOCKED** – After power-up has completed, the transmitter will automatically go into lock mode and the keys will be locked to prevent accidental changes to the settings.
- **UNLOCKED** – After power up the keys will remain unlocked. If you are using this mode you can always lock the keys by going in to the lock screen in the Main Menu.

Please note to unlock the keys at any time simultaneously press the MENU and INC keys.

SD Card Format

This menu will only appear if a card was inserted prior to booting up

PRESS UP KEY 5X
TO ERASE CARD

The Micro SD card is erased and formatted from this menu. Please note that even though many cards are sold preformatted, you must format the card in the ZFR prior to any recording. Only cards formatted in the ZFR will work properly.

Before formatting the card, you may want to name the ZFR. When you name the ZFR that name is included in the recorded file names. By naming the ZFR it makes it easier to differentiate files from different recorders. So for example you can name the card with the talents name or any other unique identifier. The card name menu is located at the end of the extended menu.

To Format an SD Card:

1. With the power off, insert the memory card into the media slot with the card label to the back of the unit. Press the card all the way in until it “clicks”.
2. Power up the ZFR while holding the menu key to enter the extended menu.
3. Press the INC key until this menu appears.
4. Press the INC key 5 times.
5. You will see “FORMATTING FAT 32” displayed on the screen.
6. After about a minute the ZFR will displays “SUCCESS” or “FORMAT FAILED ERROR”.
7. If “SUCCESS” appears power cycle the ZFR.
8. If you see “FORMAT FAILED ERROR” try to re-format the card and if it fails again it is not advised to use that card in the transmitter.

TC Jam Mode Select

TC JAM MODE:
AUTO-JAM NORMAL

If you are using record run time code this menu controls if the ZFR will go into record when it receives a record run time code.

- **AUTO-JAM NORMAL**– The ZFR will continuously jam time code via ZaxNet.
- **AUTO-LOAD REC RUN** – The ZFR will continuously jam time code via ZaxNet and will start and stop the recording if the unit is receiving record run time code.

In this mode the ZFR will go into record mode when it detects rolling time code. And will stop when the time code stops. If time code is lost because the IFB signal is too weak the unit will not stop but will continue in whatever state it was in until the time code signal is restored.

Time Code Source Select

TC SOURCE:
IFB (RF)

This menu selects how the ZFR will receive its time code.

- **IFB (RF)** – The ZFR will receive time code via ZaxNet being broadcast from Nomad, a QRX, IFB100/200, TRX900CL, a TRX transmitter or a ZFR recorder that is transmitting ZaxNet time code.
- **AUDIO INPUT**– The ZFR, with a proper cable, will receive time code via the microphone input. When time code is connected, it takes the ZFR approximately three seconds to recognize the TC. The screen displays TIME CODE followed by JAM when it is recognized. When the word JAM disappears, the time code input source can be disconnected and normal operation can be resumed. Please note that when using the microphone input connector, the audio level of the time code signal needs to be between -30 and -10 dBFS on the unit's meter. Any level above -10 may cause clipping, which will prevent proper reading of time code.

Mute Time Code Transmission Until Jammed

MUTE TC UNTIL
JAMMED: OFF

If this menu sets is set to ON the ZaxNet transmitter will not broadcast time code over ZaxNet until it receives and jams its own internal time code generator. This prevents the ZFR from sending incorrect time code to another device.

Group ID Set

REMOTE CONTROL
GROUP ID = 1

Group ID sets the ZFR to a "GROUP" that will be controlled via ZaxNet.

So for example a ZFR set to Group 1 will be controlled by a ZaxNet transmitter set to Group 1 and a Group 2 ZFR will be controlled by a Group 2 ZaxNet transmitter. This allows a group of recorders to be controlled without affecting others. This will also help if two or more people on set are sending ZaxNet commands each person will be independent and won't interfere with each other. Most users leave this set to 1 on all of their Zaxcom products. Group codes can be set from 1 to 99.

Unit ID Set

REMOTE CONTROL
UNIT CODE=ALL

The unit code assigns a unique number identify the ZFR within a particular group. This allows individual ZFR's in the same group to be independently controlled. So for example if you want to control the gain for each ZFR independently you would set the unit id on each ZFR to a different number. Unit codes can be set to ALL or be assigned any number from 1 to 200.

Dynamics

DYNAMICS

The dynamics is a soft knee compressor that is located after the analog to digital converter. The dynamics will limit the dynamic range to prevent clipping during occurrences of loud audio. Dynamics is comprised of both a compressor and an expander, which operate jointly. The compressor in dynamics can set to mild or extreme compression and features a soft knee for more transparent operation.

To enter the dynamics menu

Press the INC or DEC key - "PARMS" (perimeters) will be displayed on the right.

To move to the next parameter, press the MENU key.

To exit this page, hold the MENU key for 1 second.

Dynamics Parameters

- **Link L-R: OFF / ON:** This links the left and right if you are using a stereo recorder. So if one side of the signal needs compressing / expansion the other side will do the same to match.
- **SPEED** (Decay Speed) : SLOWEST / SLOW / NORMAL / FAST / FASTEST
Sets how gradual the signal level decreases after a signal reaches the threshold setting. This is typically set to FAST.
- **ATTACK** (Attack Speed) : SLOWEST / SLOW / NORMAL / FAST / FASTEST
Sets the speed in how fast the gain is reduced once the signal exceeds the threshold setting. This is typically set to FAST.
- **CMP RATIO** (Compressor Ratio): Valid range: 1.0: to 5.0:1, in 0.1 steps.
The amount of gain reduction is determined by the ratio setting.
A compressor ratio for example of 2.0:1 means for every 1 dB above the compressor threshold the gain will be reduced 2 dB. A higher ratio setting makes the compressor more aggressive.
- **CMP THRESH** (Compressor Threshold): Valid range: 0 to -96dB, in 1dB steps.
This sets the level in which gain reduction occurs.
- **CMP KNEE:** (Compressor Soft Knee): Valid range: 0 to 20dB, In 1dB steps.
Sets the compressor's soft knee. A soft knee reduces "softens" the audible change from uncompressed to compressed, this is useful especially for higher ratios where the changeover is more noticeable
- **EXP RATIO** (Expansion Ratio): Valid range: 1:1.00 to 1:4.00, In 0.01 steps
Sets the expansion ratio. For example a 1:2.0 expansion ratio means for every 1 dB below the expansion threshold the gain will be reduced 2 dB.
- **EXP THRESH** (Expansion Threshold): Valid range: 0 to -96dB, in 1dB steps.
Sets the threshold above which gain reduction occurs.
- **REDUCE** (Expander Gain Reduction): Valid range: 0 to -36dB, in 1dB steps.
This sets the limit on the amount of gain reduction caused by the expander.
- **GAIN** (Make-up Gain): Valid range: 0 to 30dB, In 1dB steps.
Gain is used to compensate for the gain reduction caused by the compressor. Because the compressor is reducing the gain (or level) of the signal, the ability to add a fixed amount of make-up gain at the output is provided so that an optimum level can be used.

Battery Type Set

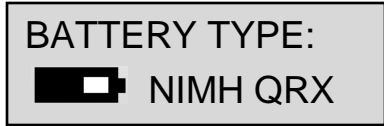

This menu is used for a TRX to send battery data to a QRX receiver and is not applicable in the ZFR.

Recording Mode Set

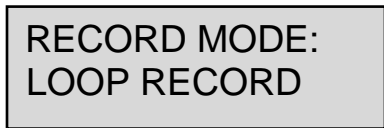

Record mode sets what the ZFR will do after you reach the file capacity of the card. Regardless of this setting the card will only hold 256 files.

- **NON-LOOP RECORD** (recommended setting) - Once the card has filled up, recording will stop and FULL will be displayed. This prevents over-writing any portion of the audio.
- **LOOP RECORD** - Once the card has filled up, the new audio will begin over-writing the oldest audio on the card.

Allow IFB Remote Control

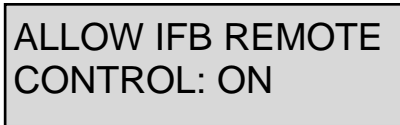

If IFB remote control is set to on the ZFR will accept remote roll and gain changes commands via ZaxNet. If IFB remote control is set to off the ZFR will not receive any ZaxNet commands.

Please note that if the ZFR is transmitting ZaxNet it will not receive remote control commands regardless of this setting.

Low Battery Stop Set

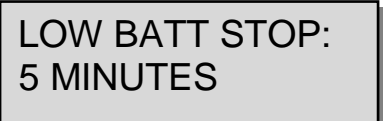
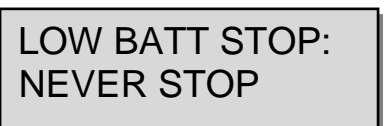

Low battery stop allows you to set the amount of time, after a low battery warning occurs, the on-board recorder will close the current file and stop recording.

This is to prevent possible file corruption if the unit powers off and on due to a dead battery.

- **NEVER STOP** - The ZFR will not stop recording unless manually stopped or the battery dies.
- **Any interval from 1 to 99 minutes** - once the battery indicator starts blink a low battery warning the ZFR will continue to record for the time set in the menu - then it will close the file and stop recording.

Automatic Record After Boot up

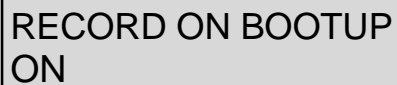

RECORD ON BOOTUP
ON

Record after boot-up will let you set the ZFR to automatically go into record after the unit boots up.

- **ON** - The ZFR will automatically start to record after it boots up.
- **OFF** - The ZFR will wait for a ZaxNet command or a manual record trigger to start recording.

ZFR Name Set

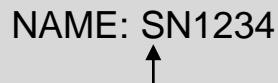

NAME: SN1234
↑

This menu allows the name of the ZFR to be changed from the default name - which is the unit's serial number. The name entered into the unit becomes part of the name of the recorded audio files, and is also included in the metadata of the BWF file. Naming the unit aids in identifying the files from several different wireless.

The maximum Name length is 8 characters. Any letter or number can be used.

To set/change the ZFR name:

1. Press the INC or DEC key to change the character in the current position.
2. Press the MENU key to proceed to the next character.
3. When finished, press and hold the MENU key to set the name or you can cycle the power.

Hide Encryption Menu

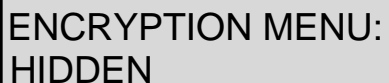

ENCRYPTION MENU:
HIDDEN

This allows you to hide the encryption menu.

- **HIDDEN** the encryption menu doesn't appear when you cycle through the menu settings.
- **ON** the encryption menu will appear.

Encryption Code Set

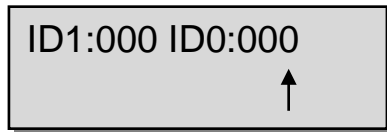

If the encryption code is turned on the ZaxNet transmitted audio will be encrypted and can only be listened to if the receiver has the matching encryption code entered. When receiving an audio signal and the codes do not match, all that will be heard is white-noise or silence. So if using encryption make sure the matching receiver has the same code.

These two sets of numbers are formed into a single six-digit encryption code which provides a total of 16,777,216 possible combinations.

Please note that both of these codes should be set to 000 for normal un-encrypted operations

To adjust the encryption code

1. Momentarily press the MENU key to advance to the next character.
2. To change the designated character, press the INC or DEC key.
3. To exit this page, press and hold the MENU key for 1 second.

Media

While any size card will work we recommend using a 4GB Micro SD card. We also recommend that you buy a brand name card such as Transcend, SanDisk. You should always buy your cards from a reputable dealer because counterfeit cards exist and can cause recording issues. We also recommend that a card is tested before taking them out into the field.

Here is a simple testing procedure to determine if the card will function correctly:

1. Format the card in the transmitter.
2. Power cycle the unit.
3. Record at least 20 minutes of audio to a card with no time code source.
4. Look at the main screen it should still be recording in segment #1.
5. Spot check the playback audio.

Media Capacity

The ZFR can use Micro SD cards ranging in size from 128 MB to 16 GB. While any size card will work we recommend using 4GB cards. Please note that regardless of the size of the card the ZFR will only be able to record up to 254 individual segments on any given card.

Available recording times are as follows:

Media Size	Available Recording Time
128 MB	45 minutes
256 MB	1.5 hours
512 MB	3 hours
1 GB	6 hours
2 GB	12 hours
4 GB	24 hours
8 GB	48 hours
16 GB	96 hours

Please note the ZFR will **NOT** record onto the card if:

- The card was not inserted when the ZFR was powered up.
- If the card was removed while the power was 'ON'.
- If the LOW BATTERY is being displayed.

Recording Format

The card is formatted using a FAT32 file system. While recording, the unit places all recorded audio in a single file on the media.

The files generated by the recorder (.zax format) can only be recognized by Zaxcom's ZaxConvert program. Using ZaxConvert you can transfer the file to create a Broadcast Wave or MP3 file. This utility is available to anyone for free from the Zaxcom website <http://www.zaxcom.com/software-updates>

Firmware

Each unit is shipped with the latest firmware version installed. As newer firmware becomes available, it can be downloaded from the Zaxcom website:

<http://www.zaxcom.com/software-updates>

Newer version of Beta software may be found on the Zaxcom Forums:

<http://www.zaxcom.com/forum>

Each time a unit is powered up, the firmware version number is displayed briefly on the LCD screen. Pressing the DEC key during the boot up will slow down the screen to allow easier viewing of the information.

Updating ZFR Firmware

1. Format a card in the ZFR
2. Download the firmware from the Zaxcom website and load it onto the formatted card.
3. Make sure the ZFR is powered down and Insert the card into the ZFR.
4. Simultaneously hold down the INC and DEC keys while powering up the unit.
5. The screen will display "BURN ROM" with the version of firmware you are loading.
6. From power up to "DONE" will take about 30 seconds.
7. Upon completion, cycle the power to run on the new version.

WARNING: Do not power down the unit during the update process, and before updating the software be sure to insert a fresh set of batteries. If the unit should lose power during the upgrade, it will need to be sent back to Zaxcom for repair.

Inputting Audio

The ZFR use an unbalanced microphone input via a 3-pin micro-LEMO connector. You can use an unbalanced dynamic microphone or a powered lavalier.

A line-level signal can be input though an inline pad will be required.

Recommended Microphones

While any 3.3 volt microphone will work with the ZFR, Zaxcom recommends the following microphones: Countryman EMW, B3, B6, Sanken COS-11D, DPA 4063

Wiring Diagrams

The following 3-pin micro-LEMO connectors mate with the microphone connector:

- FGB.00.303.CLAD.22 – LEMO with a pull release.
- FVB.00.303.NLA – LEMO with a twist release.

Regardless of the connector used it is recommended that the ground gets attached to the shell of the LEMO connector.

Two Wire Microphone Configuration

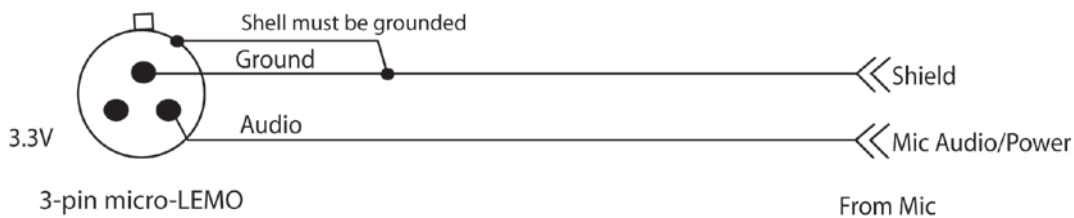

Three Wire Microphone Configuration

Please contact the microphone manufacturer.

Stereo Microphone Configuration

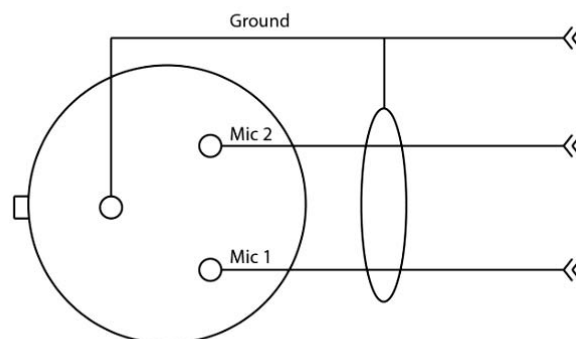

Balanced Line Level and time code Input

Mono line-level and/or timecode input

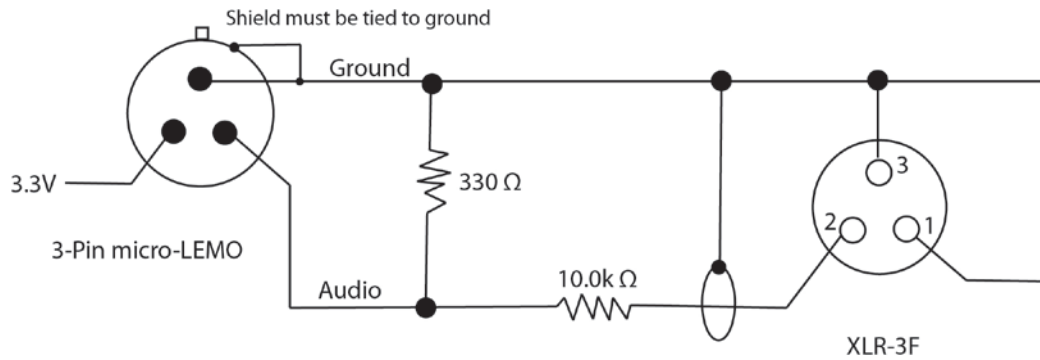

Stereo Line Level – for stereo ZRF recorders

Stereo line-level input with pads

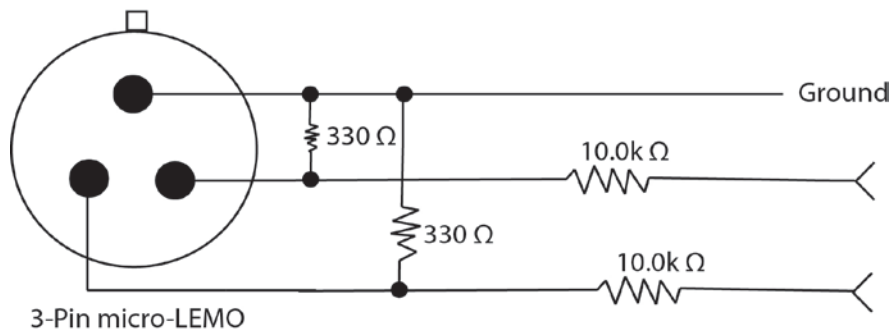

Product Support

- Register** your product with Zaxcom: <http://zaxcom.com/support/product-registration/>
- Download the latest **Firmware** from: <http://zaxcom.com/support/updates/>
- Download the latest **User Manuals** from: <http://zaxcom.com/support/updates/>
- Submit Technical Questions** at: <http://www.zaxcom.com/submit-a-technical-question>
- Submit information for **Repair Services** at: <http://www.zaxcom.com/support/repairs>
- Join the **Zaxcom User Forum** at: <http://www.zaxcom.com/forum/forum.php>
- Join the **Zaxcom Face Book User Group** at: <https://www.facebook.com/groups/682199065139938/>

Specifications

Audio

Dynamic Range: 104 dB

Distortion: < 0.01%

Frequency Response: Mode 0: 20 Hz to 16 kHz / T & M Mode 0.2 Hz to 16 kHz

High Pass Filter: Off or 70 to 220 Hz, Steps: 10 (6 dB Per Octave)

Mic Power: 3.3 VDC

Mic Connector: 3-Pin Micro LEMO

Input Range: -60 to -24 dBu

Mic Impedance: 4.7 k Ω

ADC Bit-Depth: 24 Bits

Time code Reader / Generator

Clock Accuracy: 1.54 PPM (1 Frame Out in 6 Hours)

Time code Type: SMPTE

Time code Frame-Rates: 23.98, 24, 25, 29.97NDF, 29.97DF, 30NDF, 30DF

Internal Recording

Media: Micro SD Card (Flash Memory)

File Format: .ZAX

Recording Time: 96 Hours (16 GB Card)

2.4 GHz ZaxNet Receiver

RF Frequency Range: 2.403 to 2.475 GHz

RF Modulation: Digital Spread Spectrum

RF Frequency Step: 0.001 GHz (1 MHz)

RF Bandwidth: 1 MHz

Channel Separation: 2 MHz

Sensitivity: -96 dBm

Physical

ZFR-200

Weight: 3.0 oz without battery

Dimensions (H x W x D): 2.4" x 2.4" x .65"

Display: Graphic LCD

ZFR-300

Weight: 3.1 oz without battery

Dimensions (H x W x D): 3.0" x 2.4" x .65"

Display: Graphic LCD

Battery Life

ZFR-200: Up to 5 Hours with 1 Lithium AA

ZFR-300: Up to 12 Hours with 2 Lithium AA

All Specifications are subject to change without notice.

Zaxcom Warranty Policy and Limitations

Zaxcom Inc. values your business and always attempts to provide you with the very best service.

No limited warranty is provided by Zaxcom unless your ZFR ("Product") was purchased from an authorized distributor or authorized reseller. Distributors may sell Product to resellers who then sell Product to end users. Please see below for warranty information or obtaining service. No warranty service is provided unless the Product is returned to Zaxcom Inc. or a Zaxcom dealer in the region where the Product was first shipped by Zaxcom.

Warranty Policy

The Product carries a Standard Warranty Period of one (1) year.

NOTE: The warranty period commences from the date of delivery from the Zaxcom dealer or reseller to the end user.

There are no warranties which extend beyond the face of the Zaxcom limited warranty. Zaxcom disclaims all other warranties, express or implied, regarding the Product, including any implied warranties of merchantability, fitness for a particular purpose or non-infringement. In the United States, some laws do not allow the exclusion of the implied warranties.

Troubleshooting & Repair Services

No Product should be returned to Zaxcom without first going through some basic troubleshooting steps with the dealer you purchased your gear from.

To return a product for repair service, go to the Zaxcom Repair Services page <http://www.zaxcom.com/repairs> and fill in your information; there is no need to call the factory for an RMA. Then send your item(s) securely packed (in the original packaging or a suitable substitute) to the address that was returned on the Repair Services page. Insure the package, as we cannot be held responsible for what the shipper does.

Zaxcom will return the warranty repaired item(s) via two-day delivery within the United States at their discretion. If overnight service is required, a FedEx or UPS account number must be provided to Zaxcom to cover the shipping charges.

*Please note a great resource to troubleshoot your gear is the Zaxcom Forum: <http://www.zaxcom.com/forum>.

Warranty Limitations

Zaxcom's limited warranty provides that, subject to the following limitations, each Product will be free from defects in material and workmanship and will conform to Zaxcom's specification for the particular Product.

Limitation of Remedies

Your exclusive remedy for any defective Product is limited to the repair or replacement of the defective Product.

Zaxcom may elect which remedy or combination of remedies to provide in its sole discretion. Zaxcom shall have a reasonable time after determining that a defective Product exists to repair or replace a defective Product. Zaxcom's replacement Product under its limited warranty will be manufactured from new and serviceable used parts. Zaxcom's warranty applies to repaired or replaced Product for the balance of the applicable period of the original warranty or thirty days from the date of shipment of a repaired or replaced Product, whichever is longer.

Limitation of Damages

Zaxcom's entire liability for any defective Product shall, in no event, exceed the purchase price for the defective Product. This limitation applies even if Zaxcom cannot or does not repair or replace any defective Product and your exclusive remedy fails of its essential purpose.

No Consequential or Other Damages

Zaxcom has no liability for general, consequential, incidental or special damages. These include loss of recorded data, the cost of recovery of lost data, lost profits and the cost of the installation or removal of any Product, the installation of replacement Product, and any inspection, testing or redesign caused by any defect or by the repair or replacement of Product arising from a defect in any Product.

In the United States, some states do not allow exclusion or limitation of incidental or consequential damages, so the limitations above may not apply to you. This warranty gives you specific legal rights and you may also have other rights, which vary from state to state.

Your Use of the Product

Zaxcom will have no liability for any Product returned if Zaxcom determines that:

- The Product was stolen.
- The asserted defect:
 - Is not present,
 - Cannot reasonably be fixed because of damage occurring when the Product is in the possession of someone other than Zaxcom, or
 - Is attributable to misuse, improper installation, alteration, including removing or obliterating labels and opening or removing external covers (unless authorized to do so by Zaxcom or an authorized Service Center), accident or mishandling while in the possession of someone other than Zaxcom.
- The Product was not sold to you as new.

Additional Limitations on Warranty

Zaxcom's warranty does not cover Product, which has been received improperly packaged, altered or physically abused.

FCC Notice:

NOTE: This equipment has been tested and found to comply with the limits for a Class B digital device, pursuant to Part 15 of the FCC Rules. These limits are designed to provide reasonable protection against harmful interference in a residential installation. The equipment generates uses and can radiate radio frequency energy and, if not installed and used in accordance with the instructions, may cause harmful interference to radio communications. However, there is no guarantee that interference will not occur in a particular installation. If this equipment does cause harmful interference to radio or television reception, which can be determined by turning the equipment off and on, the user is encouraged to try to correct the interference by one or more of the following measures: • Reorient or relocate the receiving antenna • Increase the separation between the equipment and receiver • Connect the equipment into an outlet on a circuit different from that which the receiver is connected • Consult the dealer or an experienced radio/TV technician for help. Changes or modifications to this equipment not expressly approved by Zaxcom, Inc. could void the user's authority to operate it.